

Instruction Manual

Thank you for purchasing KDF's Sintering Furnace, Zircom.
Before using the unit, please read the manual thoroughly and
understand the capabilities and proper usage for this machine.
Please keep this manual in an easily accessible location for
future reference.

Contents

Safety Precautions	1
Standard Accessories	4
Descriptions of Component Parts	5
Preparations before use	7
Operation	8
How to use	9
Periodic Maintenance	17
Error Messages	18
Specification	19

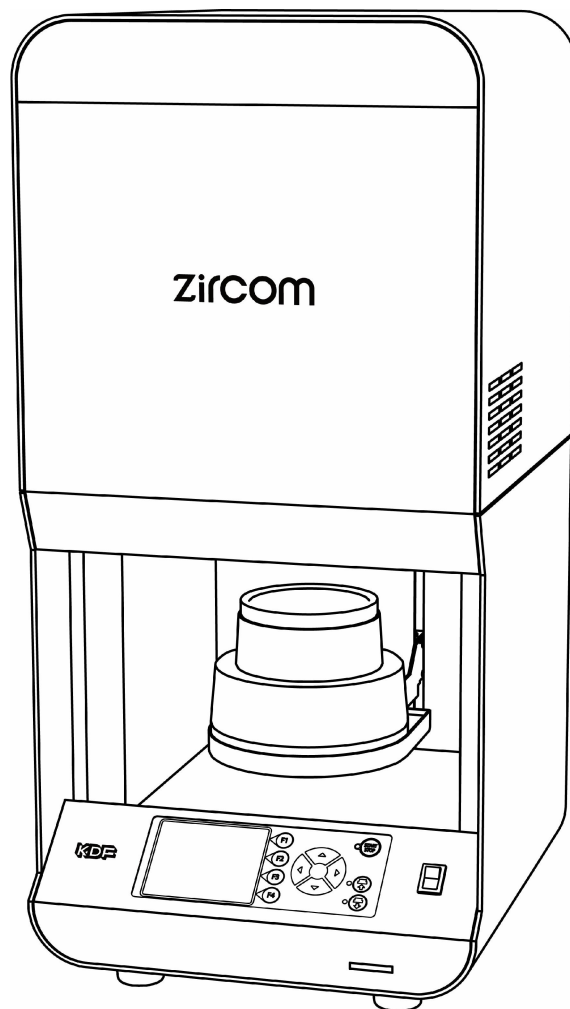

Safety Precautions

About labels which are put on the unit.



This mark means that do not fail to read the instruction manual before use of the unit.



This mark means a warning that "Be careful not to jam something when the firing table moves up and down".



This mark means a warning that "Hot parts. Be careful not to burn".

We recommend you to follow these instructions for proper use of the unit.

Directions

The safety precautions contained herein and the accompanying icons provided for the safe use of this machine and to prevent injuries and loss on material resources.

Please read them carefully prior to your actual machine operation.



WARNING

Failure to follow or ignorance of the directions may cause severe injury or death.



CAUTION

Failure to follow or ignorance of the directions may cause injuries or damages to material properties.



⊘ This mark means prohibited actions as shown inside or around it. The illustration on the left means "Do not disassemble".











● This mark means forced action and directions to follow as shown inside or around it. The illustration on the left means "Unplug out of power outlet".













△ This mark requires a user to pay attention to the caution mark as shown inside or around it. The illustration on the left means "Be careful not to jam your fingers "

WARNING

	<ul style="list-style-type: none"> ● In the event when there is smoke, abnormal odors or sounds, turn off the power, unplug immediately and contact the dealer for repairs. ● In the event when water enters the machine, turn off the power, unplug immediately and contact the dealer for advice. Continued use may cause electric shock or fire. ● In the event when debris enters the machine, turn off the power, unplug immediately and contact the dealer for advice. Continued use may cause electric shock or fire.
	<ul style="list-style-type: none"> ● Do not remove the panels or parts un instructed or modify them in any manner. This may cause electric shock or fire.
	<ul style="list-style-type: none"> ● In the event, when the machine is dropped or the furnace frame is dented, unplug immediately and contact the dealer for advice. Continued use may cause electric shock or fire.
	<ul style="list-style-type: none"> ● Please do not block ventilation holes and fan intake that are located on top surface and on the side of the instrument. Doing so may cause internal temperature increase and cause fire or malfunction of the unit.
	<ul style="list-style-type: none"> ● Plug to the outlet of the designated voltage described in the main specifications. Use of other voltage may cause fire or shock.
	<ul style="list-style-type: none"> ● Keep the unit away from other equipment and walls. Leave minimum of 20cm of space around the unit. Do not place anything on the top of the unit to prevent temperature increase inside the unit. Continued use may cause fire or malfunction.
	<ul style="list-style-type: none"> ● When the unit is used, the quick firing stand provided must be set on the firing table. Continued use without the quick firing stand may cause burn or fire.
	<ul style="list-style-type: none"> ● Do not place heavy items or place machine on the power cord and make sure that the cord is not damaged. This may cause fire or electric shock. ● Please do not damage the power cord, or process, excessive bending, twisting, pull. Doing so could damage the cord and cause fire or electric shock. ● When the cooling fan is in operation, do not unplug the power cord. The cooling fan will stop and the outer case will get hot. This may cause fire.

CAUTION

	<ul style="list-style-type: none"> ● Unplug the main power cord from the power outlet when the machine is not in use for a long period of time. ● In case of a periodic machine maintenance, unplug the power cord from the power outlet.
	<ul style="list-style-type: none"> ● Do not handle the plug with wet hands. ● When you unplug the power cord from the power outlet, do not pull the cord. If the cord is damaged, it may cause fire or shock. Always remove by handling the plug.
	<ul style="list-style-type: none"> ● This machine is for dental sintering furnace. We do not recommend you to use the machine for any other purpose.
	<ul style="list-style-type: none"> ● The improper installation or use may impair the safety protection function.
	<ul style="list-style-type: none"> ● Do not move up/down the table than necessary. The parts may be heated and fire or breakdown may occur.
	<ul style="list-style-type: none"> ● Do not use the accessories and consumables we do not recommend. Breakdown or fire may occur.
	<ul style="list-style-type: none"> ● Use the heat-resistant glove and tongs to take the firing tray in and out because inside of furnace may be high temperature. ● Do not touch around the furnace (firing table) during heating up because of high temperature. If any operations is required during heating up, use the heat-resistant glove.
	<ul style="list-style-type: none"> ● Do not place anything or put a hand under the firing table while the table is moving down. Injury or breakdown may occur.
	<ul style="list-style-type: none"> ● When you move this machine, power off the switch, and unplug the main power cord from the power outlet. This may cause fire.
	<ul style="list-style-type: none"> ● In case of using of coloring liquid, sinter firing objects after they are dried completely with other burnout furnace. The insufficient dry may contaminate inside the unit and occurs the malfunction of the unit.

Standard Accessories

When you open the box, we recommend you to make sure that the following standard accessories are included. In addition, please check the unit for any damage or dent. Contact our technical support team if there is any damage.

※Cracked insulator inside the muffle chamber is normal. This is not defected.

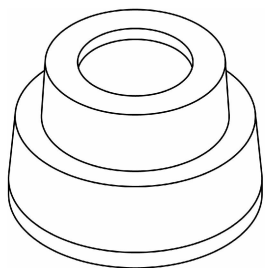

Quick Firing Stand 1pc

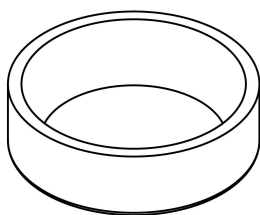

Firing Tray S 3pcs

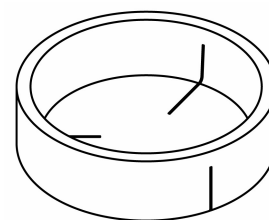

Quick Firing Tray S 1pc

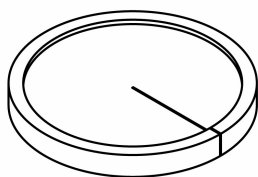

Quick Firing Tray Stand 1pc

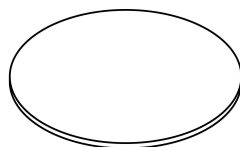

Firing Cover 1pc

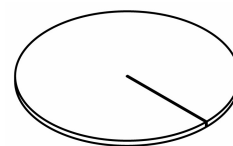

Quick Firing Cover 1pc

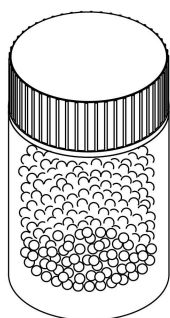

Firing Beads

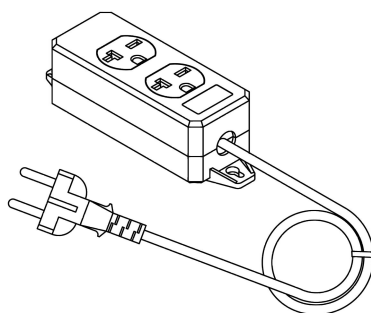

Conversion plug

Instruction Manual
1 booklet

We recommend you to save the carton and all packing materials for future use.

Descriptions of Component Parts

●Front View

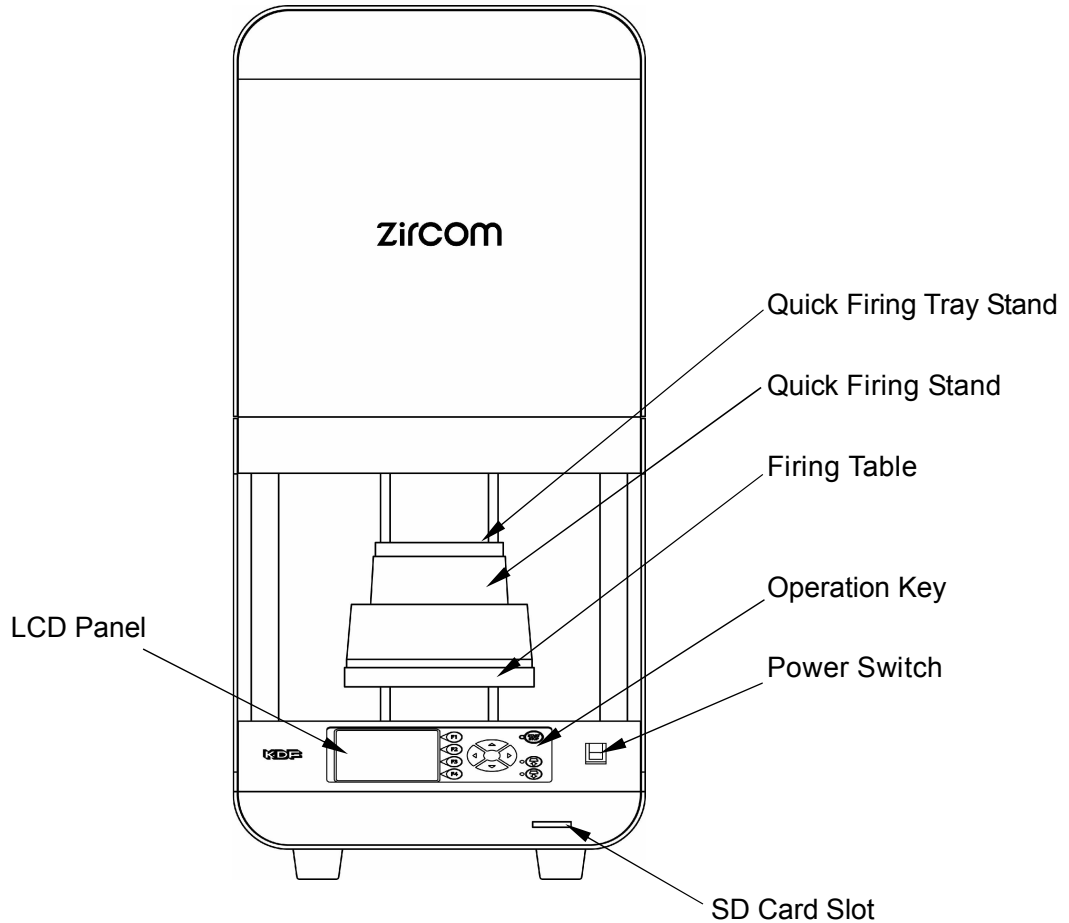

- Quick Firing Tray Stand : Place to put firing tray and firing object.
- Quick Firing Stand : Place to put quick firing tray stand.
- Firing Table : Table to place quick firing stand and it moves up and down.
- Power Switch : Power switch for the unit.
- LCD Panel : LCD panel allows you to check programs/settings and operate the unit.
- Operation Key : F1~F4, Up/Down/Left/Right, Start/Stop and Table Up/Down are used to Operate the unit.
- SD Card Slot : The slot allows you place SD card to backup and/or download firing data.

● Back View

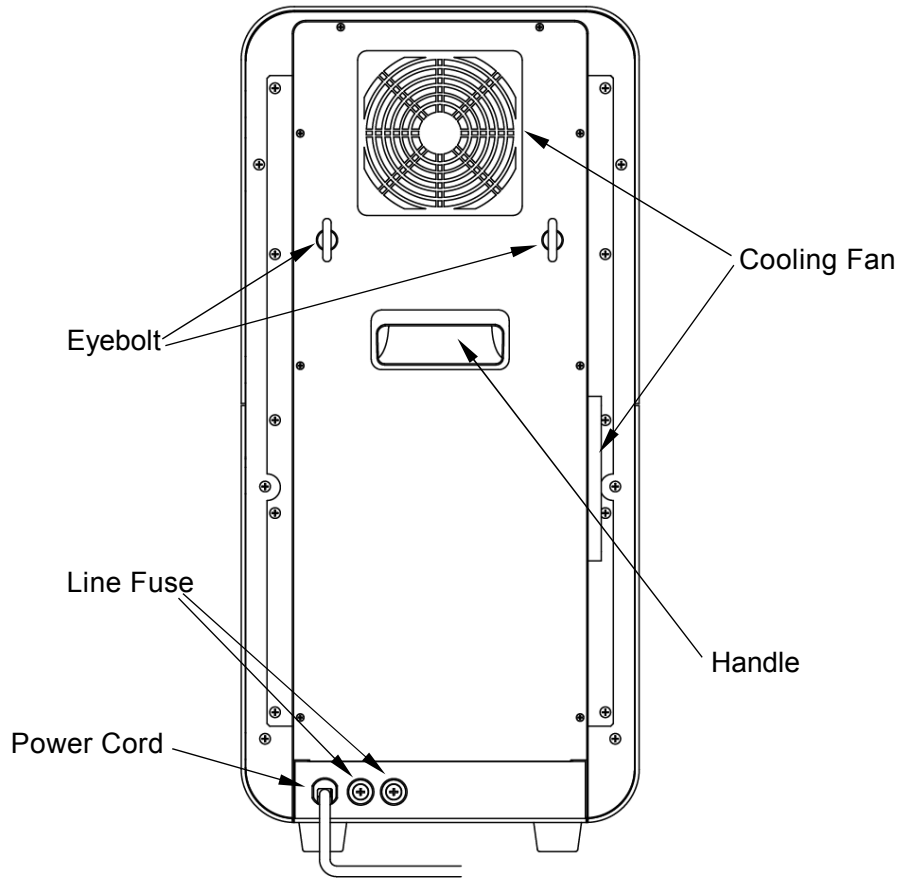

Line Fuse : Φ 6.4-20A glass fuse.

Cooling Fan : Two fans on the back and left side of the unit.

Preparations before Use

Location & Environment

- Lift the unit up with catching hold of the bottom of the unit and handle on the back of the unit.
- Set up the unit on the center of a flat stable table.
- Keep the unit away from walls and other equipment. Leave the unit minimum of 20cm of space around the unit.
- Secure the unit with the eyebolt on the back of the unit.

Caution) Set the unit to be able to disconnect the plug easily if problems occur.

Power Requirement

- The unit requires a power outlet with independently wired, 220-240V single-phase, 20A and grounding.

Installation of Quick Firing Stand

- Power on the unit by pressing the power switch button. After Standby mode appears, press the  button to bring down the table.
- Put the provided quick firing stand on the inside of 4 guide pins of firing table.
- Put the quick firing tray stand on the groove.

Unloaded Muffle Firing

- There may be moisture in the firing tray, the firing cover, and firing beads. Before operating for first time, please follow the unloaded muffle firing process listed below.

1. Put proper amount of beads in the firing tray.
2. Put three firing trays with its cover on.
3. Choose the course 0 then press [START STOP].
 - ※Unloaded muffle firing takes **approximately 7 hours**.

The installation is finished.

Operation

Operation Panel

Zircon features color LCD panel display.

The display shows information for content of the program, firing process, etc.

Firing operations and program input are operated by 11 keys.

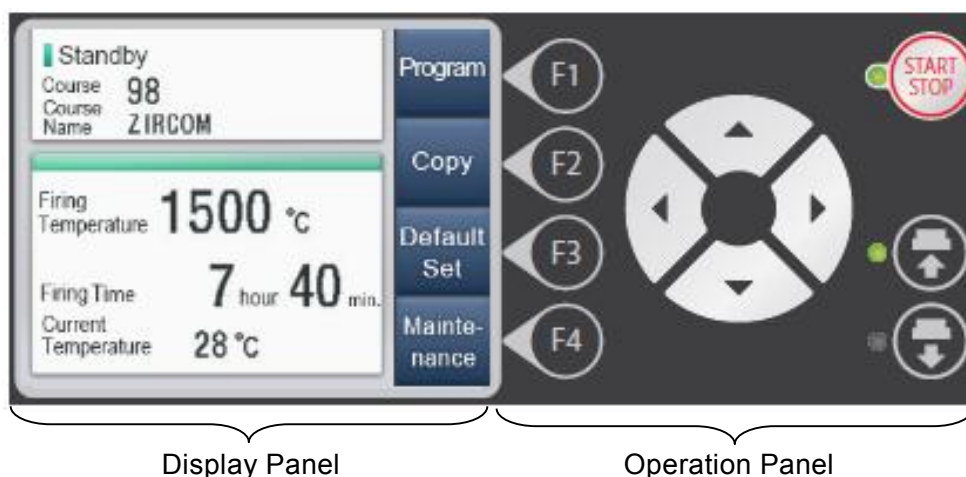

Operation Panel

Function Key (F1-F4) : Move to each mode, input programs and etc.

 Key : Move cursor for set contents.

START STOP Key : Stop or Start firing operation.

 Key : Move the table up/down.

Operation Modes

The unit has 7 modes for various functions.

- Standby Mode : Standby mode before firing. After powering on, the unit will enter this mode. →P9
- Program Mode : Inputs a program for each course number. →P10
- Firing Mode : Displays temperature and firing process during firing process. →P12
- Copy Mode : Copies a program to a different course. →P14
- Default Mode : Sets each operation default value and operation process. →P14
- Maintenance Mode : Checks the unit usage and its condition. →P15
- SD Card Mode : Reads data of firing program from a SD Card. →P16

How to use

Power On

Standby Mode

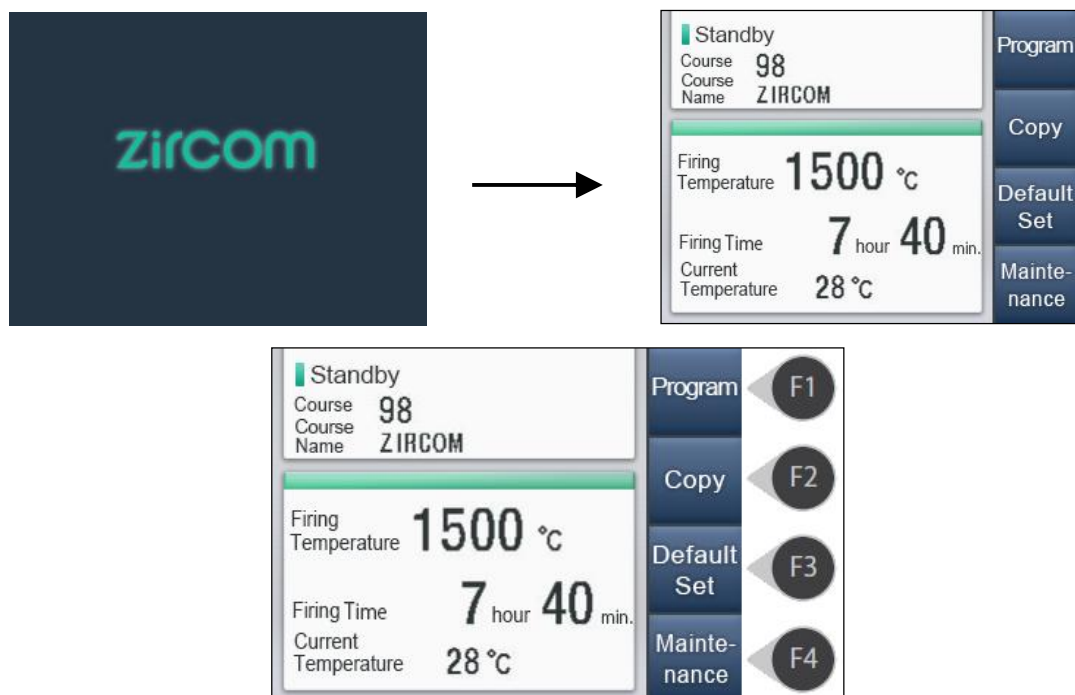

After powering on, the unit displays the Standby Mode which allows users to access to other modes. Please see the following instruction for the standby mode below.



Display

- Course : Current course number.
- Course Name : Course name for current course number.
- Firing Temperature : Maximum temperature in the program.
- Firing Time : Total programmed firing time.
- Current Temperature : Current muffle temperature.

Function Key

- F1 (Program) : Go to program mode. →P10
- F2 (Copy) : Go to copy mode. →P14
- F3 (Default Set) : Go to default mode. →P14
- F4 (Maintenance) : Go to maintenance mode. →P15
- Up & Down Key : Change course. Fast forward by holding the key longer.
- Left & Right Key : Invalid
- START STOP Key : Start firing and go to firing mode. →P12
-  (Up) Key : Key used to move the table up.
-  (Down) Key : Key used to move the table down.

Caution) When muffle temperature is high, for safety purpose, table moving down is limited as below.

- When muffle temperature is 900°C and over, the unit keeps the table at the highest position (0).
- When muffle temperature is 550°C~900°C, the unit can move down the table to position (3).
- When muffle temperature is under 550°C, the unit can move down the table until lowest position (5).

Programming

Zircon allows users to program up to 100 courses with maximum of 20 STEPS per program.

For each STEP, set temperature, time, table position, and buzzer type.

※Courses with () are not adjustable.

Programmable parameters and program instructions

Parameter	Programmable Values	Default
Course Name	Character Input : Alphabet & Number Character Max : 16 characters	_____
Temperature	0~1600°C (2912 °F)	0°C
Time	0 : 00~99 : 59 (hour : min.)	0 : 00
Table Position	0~5 0 : Highest position 5 : Lowest position (approx 5cm from the top) ※When muffle temperature is 900°C or above, the table moves to [0] automatically.	0
Buzzer Type	0~5 5 types of sound. ※0 is no sound.	0

※Table Position : Table position affects temperature inside the muffle. Position 0 completely seals the furnace to quickly rise furnace temperature and position 2, 3, 4, and 5 give space between the furnace and the table to quickly decrease the furnace temperature. We recommend you to set the table at the appropriate position. For cooling stages, we strongly recommend you to program the table position.

※The firing tray and firing stand can be consumed early in case firing temperature is more than 1500 °C or the temperature rise time from room temperature to 1500°C is faster than 120 minutes.

Program Mode (F1 Key)

Program mode allows users to input firing program.

During Standby mode, press the [F1] key to enter the Program Mode.

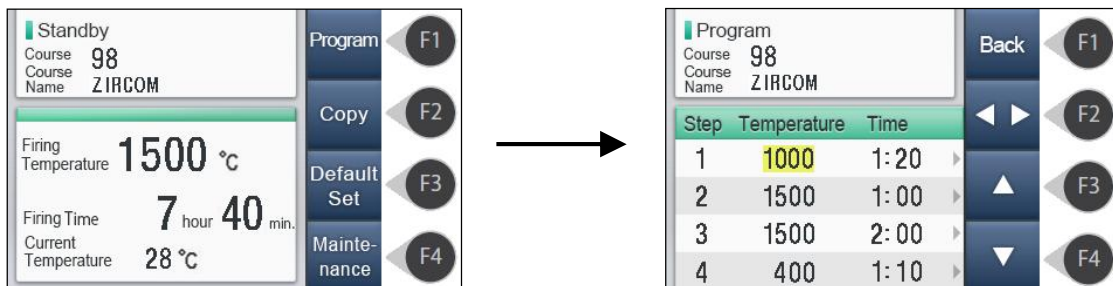

Key Function

F1 (Back) : Go back to Standby Mode.

F2 (◀▶) : Change Setting Page. (「Temperature·Time」 ⇔ 「Table Position·Chime」)

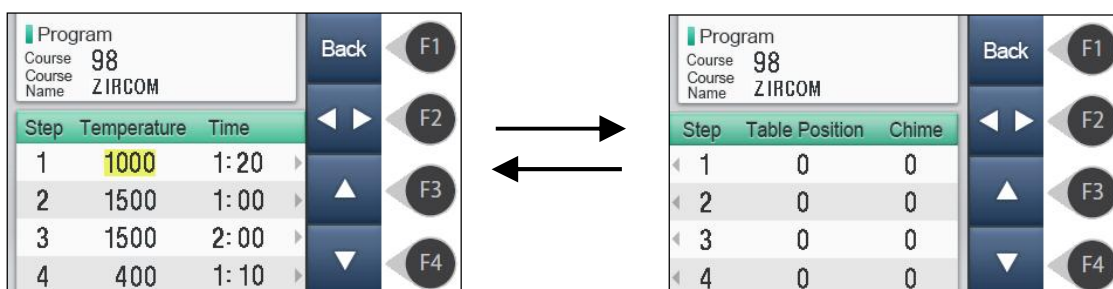

- F3 (▲) : Increase the value.
- F4 (▼) : Decrease the value.
- Up, Down, Left, Right Keys : Moves the cursor in setting.

Changing Course Name

1. Enter the Program Mode.
2. Press the ▲ Key to go to the course name.
3. Use [F3] and [F4] key to select the letter (Number, alphabetical, letter) that you want to program.
※Holding the key longer will fast forward to the selecting character.
4. Press the Down key to move to STEP 1.

How to Program (Step by Step)

Suppose you store a firing program on Program Course 98 as follows :
(Make sure firing table is down)

Course Name: ZIRCOM

STEP	Temp.(°C)	Time (hour:min.)	Table Position
1	1000	1:20	0
2	1500	1:00	0
3	1500	2:00	0
4	400	1:10	0
5	300	1:00	1

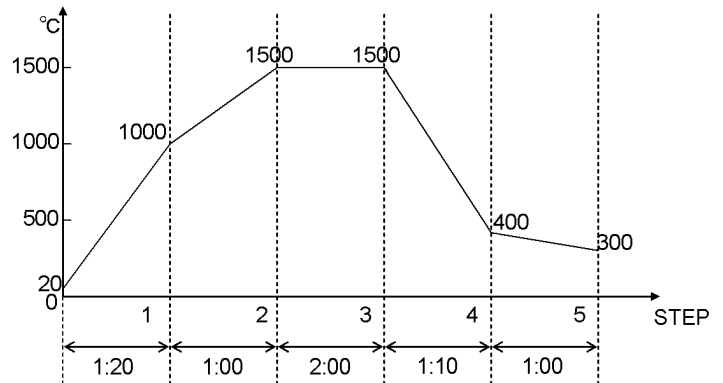

Programmed Start temperature for Zircom is 20 °C.

1. Turn on the power to go to the Standby Mode.
 2. Press ▲▼ button to choose the course number 98.
 3. Press [F1] key to enter the Program Mode.
 4. Press ▲ to move to Course Name.
 5. Input the Course Name (ZIRCOM) by using [F3] & [F4] key and ►.
 6. Press ▼ to move back to STEP 1.
 7. Input 1000 by using [F3] & [F4] key.
 8. Press ► to adjust Time then input 0:40 by using [F3] & [F4] key.
 9. Use the same procedure to program for STEP2,3 and 4.
 10. Press ▼ to move down to STEP 5 then input 300 and 1:00.
 11. Press [F2] key to change Setting Page (Table Position & Chime).
 12. Adjust Table Position to 1 by using [F3] & [F4] key.
 13. Press [F1] key to return to Standby Mode.
- ※Program will not be stored if you turn off the unit during programming.

Programming of Course 98 is complete.

Firing

When programming is complete, you can start firing.

Shown below is an example using course 98.

- ① During Standby mode, press ▲▼ button to select course 98.
- ② Press the ⏴ key to move the table down to the lowest position.
- ③ Place firing objects inside the firing tray.
- ④ Place the firing tray on the quick firing stand.
Caution) Place the firing tray on the middle of the quick firing stand.
Caution) The quick firing stand and the muffle will be hot.

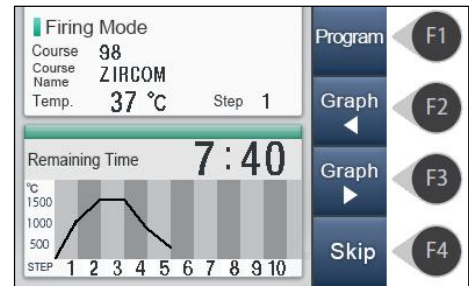

Be sure use the tongs and heat-resistant glove when

placing the firing tray onto the quick firing stand.

- ⑤ Press START/STOP key to start firing.

Caution) Please put firing trays on quick firing stand with triple-stacked definitely, regardless of the amount of firing objects.

Firing Mode

When firing starts, the display turns to Firing Mode and shows furnace temperature, progress, & the remaining time.

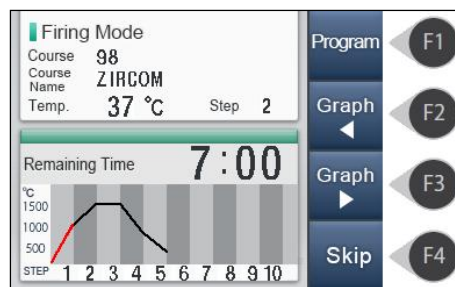

Display

- Course : Course that is in process.
- Course Name : Name of the course that is in process.
- Temperature : Current furnace temperature.
- STEP : STEP that is in process.
- Remaining Time : Remaining time until STEP is fully completed.
- Process Graph : Graph for the entire program.
The completed process is displayed in red.

Key Operation

F1 (Program) : Access to Program Mode to make a change for the currently running program. Changes are effective from the next STEP. You cannot change the STEP that is in progress. The changes are reflected in the only operation in progress, it will not be saved in the storage data.

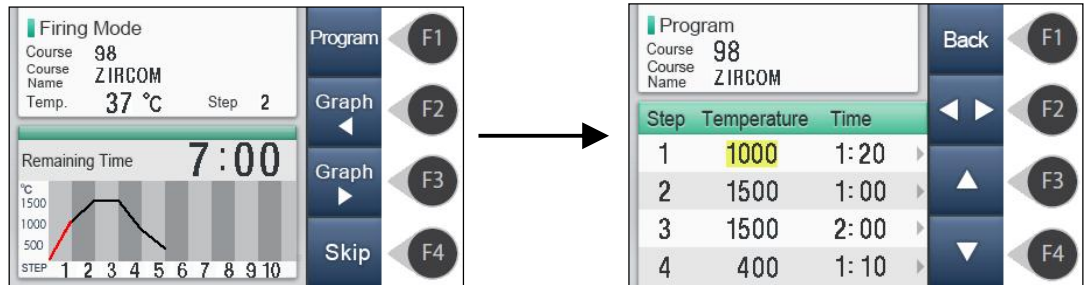

F2 (Graph) : Switch page to STEP1~10 to the STEP graph display.

F3 (Graph) : Switch page to STEP11~20 to the STEP graph display.

F4 (Pass) : Pass running STEP. It is enabled when you press for about 1 second.

Start/Stop : Stops the firing and return to standby mode. It is enabled when you press for about 1 second.

Editing of Running Program

1. Go to Program Mode.
2. Press [F1] key while pressing the ▲ key.
3. Use ▲▼ keys to adjust the program.
4. Press [F2] key (OK) to return to Program Mode.

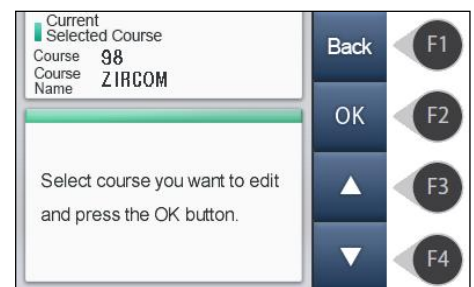

Press the [OK] key to go to Stand-by mode.

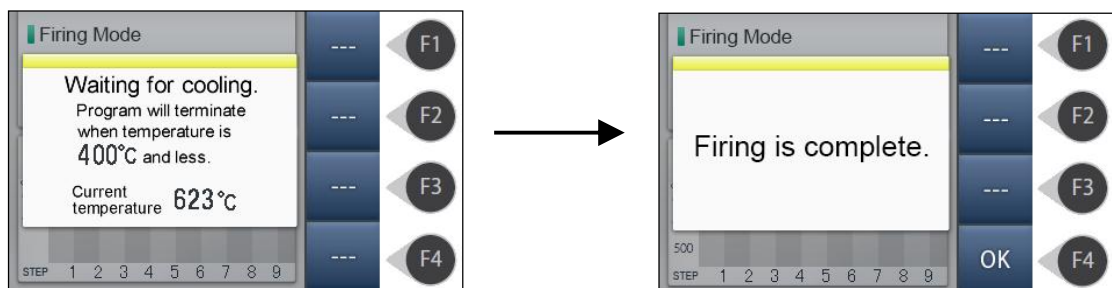

If set to a range of 1~100 °C the temperature of the final STEP, table does not decrease while the top-level firing at the end. Please set If you do not want to lower the firing table at the end of firing for the safety.

If temprature of the Final STEP is between 1~100°C, the firing table does not go down and stays at the highest position (0). If necessary for safety purpose, please program temperature of the final STEP to less than 100°C.

Copy Mode

Copy mode is used to copy programs between courses.

Using Copy Mode

- ① Go to Stand-by mode, select the course you want to copy.
- ② Press the copy key to go to destination selection screen (shown below).

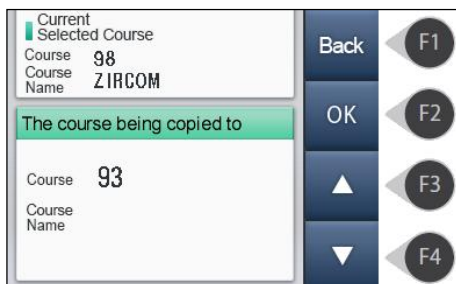

- ③ Press ▲▼ and select the course number where you want to copy the program to. Selected course will be in yellow.
- ④ Press the [OK] key to copy the program. If you want to copy to the course followed by another, repeat ④ and ⑤.
- ⑤ Press [Back] key to go back to Stand-by mode.

Default Mode

This mode is used to set buzzer volume, temperature correction value, & temperature unit.

Enter Default Mode

During Standby Mode, press [Default] key. The screen displays the following screen.

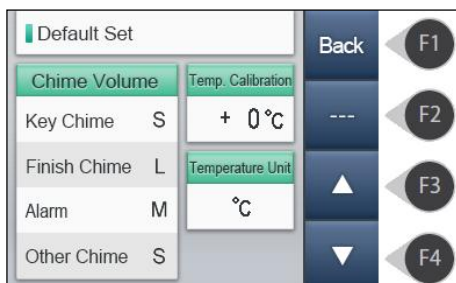

Setting of each item in the default mode

Change the value to move the item by pressing the up or down arrow keys, press the key ▼,▲.

Setting the buzzer volume (4 stages : Consumption, Small, Medium, Large)

- ① Key Sound : Default is Small. (Volume level when you pressing a key)
- ② Ending Sound : Default is Large. (Volume of warning sound at the time of the error)
- ③ Announcement Sound : Default is Medium.
(Volume of sound notification upon completion of each STEP)
- ④ Other Sound : Default is Small. (Volume of other sound, such as power-up)

Temperature correction : It allows you to adjust the furnace temperature of 50 °C ± to 1500 °C.
For example, if you want to increase at 15 °C 1500 °C, please set the +15 °C. In that case, it will be about 1010 °C at 1000 °C.
The initial value is 0 °C ±.

Temperature Unit : It can be set to F (Fahrenheit) or °C(Celsius) temperature scale.
The initial value is °C

Maintenance Mode

Maintenance mode allows users to check total running time of the unit and total firing cycle.
Data of total firing cycle and total running time are useful when applying periodic maintenance or when the unit is in need of service.

Enter Maintenance Mode : Press [Maintenance] key in Standby Mode to display the following screen.

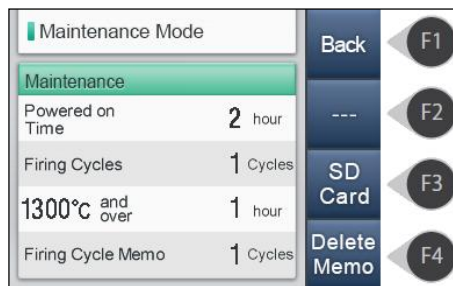

Descriptions of Maintenance Mode

Total Running Time : Total running time since purchase.

Total Firing Cycle : Total number of firing cycle since purchase.

Above 1300°C : Total firing time above 1300°C.

Note the number of firing : It is erasable memo firing frequency. Press the firing frequency notes clear key to clear to 0. Please use as a guide, such as the next time to replace with clear at the time of replacement of the heater.

Press the Return key to return to the standby mode.

Press the SD card key to go to the SD card mode.

SD Card Mode

SD Card Mode allows you to save firing program data or maintenance information in a SD card so you can edit or save on your PC.

Enter SD Card Mode : Go to Maintenance Mode and press [SD Card Mode] key to display the following screen.

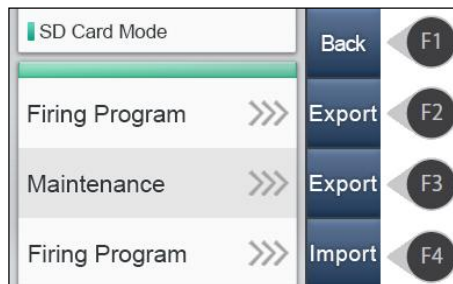

Using SD Card

Export Firing Program :

Press (F2) key to export the firing program content to the SD card.

File name will be saved as "ZRM_PRG.csv". You can edit the file using software such as EXCEL on the PC.

Export Maintenance Information :

Press (F3) to key to the maintenance information to the SD card.

File name will be saved as "ZRM_MNT.csv". In a case of troubleshooting, please send this date to our technical support team VIA e-mail.

Importing Firing Program from SD card to Zircom :

Press (F4) key to import data from the SD Card.

In order to import a Firing Program data from SD card to the unit, you must create a program file named "ZRM_PRG.csv" on your PC and save it on your SD Card.

Periodic Maintenance

Please perform timely care of the following



Before cleaning the unit, turn off the unit and unplug the power cord.

If exterior of the unit is dirty, please use soft cloth with a mild detergent to wipe.

Cleaning the firing table

In a state in which the furnace, firing table is cold, please remove dust takes a firing platform.

Cleanness of Fan Filter

Take a cover out to remove a filter as shown below. Vacuum dust of filter or replace to new filter.

Caution) Don't wash a filter with water.

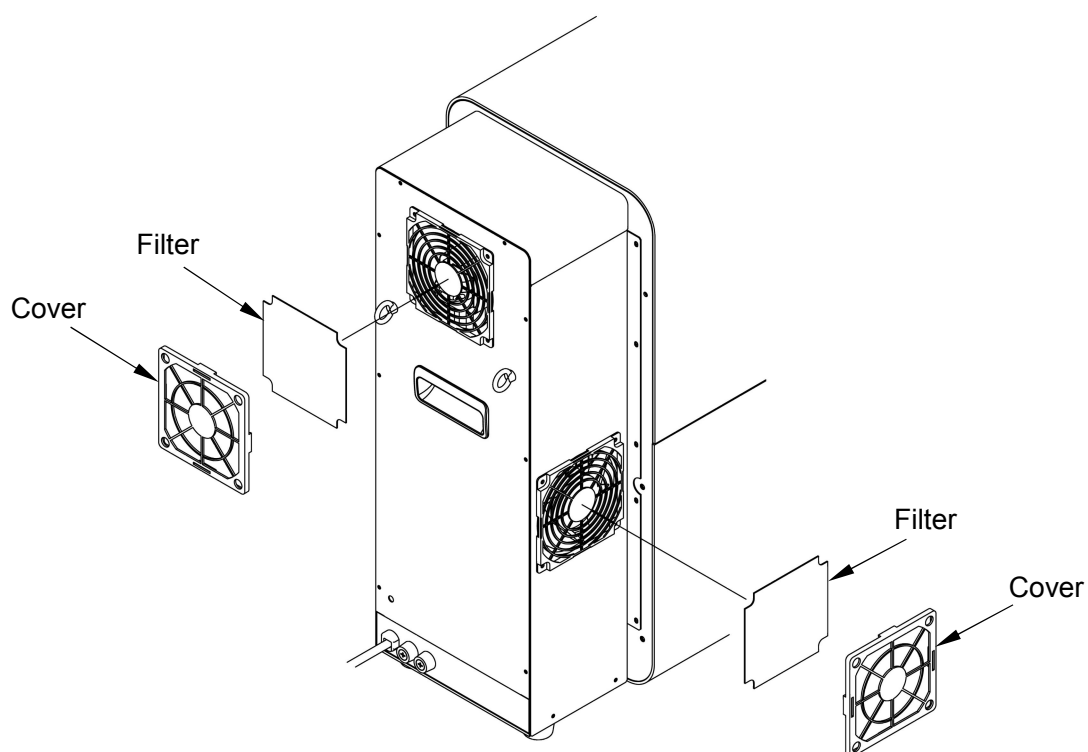

Error Messages

The unit shows a warning display as shown below. When there is an error sign, please follow the instruction carefully. When contacting our technical support team, please provide the error number. In the case when the unit is showing a warning sign due to abnormal or excessively loud noise, please turn off the unit and turn it back on.

Caution) In the case of rebooting the unit, the contents of the initial value and the program may be deleted.

The followings are examples of abnormal or excessively loud noise

- Lightning strike nearby, lightning
- Equipment high frequency casting equipment, such as arc casting apparatus
- Wireless device
- Motorized equipment



WARNING

No.2 Controller abnormal

Error 2 is displayed when the controller is operating abnormally due to abnormal or excessively loud noise.

No.4 Lifting Table abnormal

Error 4 is displayed when error occurs during lifting the firing furnace.

No.5 Heater disconnection abnormality

Error5 is displayed when heater is broken. Please replace it with a new muffle.

No.6 Thermocouple Error

Error 6 is displayed when the thermocouple is short-circuited or disconnected.

No.8 Memory Error

Error 8 is displayed if the memory content is corrupted or lost by abnormal or excessively loud noise.

The unit also shows Error 8 when it is unable to read the memory. Turn off the unit and turn it back on to reset.

When you reset, program content may be deleted.

No.9 Excessive rise in temperature anomaly

Error 9 is displayed when the muffle temperature rises excessively.

No.11 Top cooling fan error

Error 11 is displayed when an error occurs in the top cooling fan.

No.12 Under cooling fan error

Error 12 is displayed when an error occurs in the under cooling fan.

No.13 Temperature Control Board error

Error 13 is displayed when an error occurs in the temperature control board inside.

No.14 Current control Board error

Error 14 is displayed when an error occurs in the current control board.

Specification

Product Name	Zircon
Power Requirement	220-240V ± 10% 50/60Hz
Power Consumption	2.5kVA
Inner Muffle Size	Φ90 × 80(H)mm Triple stack of accessory's firing tray
Overall Dimensions	300(W) × 640(H) × 450(D) mm
Weight	29kg
Temperature sensor	JIS R Thermocouple
Environment for use	Indoor use Room Temperature 10~40°C Humidity 30~90%RH no condensing Altitude: 2000 meter and under Pollution Degree 2 Over voltage Category II
Maximum Temperature	1600°C
Program Memory Capacity	100 programs
Safety Function	Cooling Fan, Abnormal temperature monitoring circuit, 10 abnormal operation detection apparatuses
Accessories	Quick Firing Stand : 1pc Firing Tray S : 3pcs Quick Firing Tray S : 1pc Quick Firing Tray Stand : 1pc Firing Cover : 1pc Quick Firing Cover : 1pc Firing Beads : 1bottle Conversion plug : 1pc Instruction Manual : 1booklet

DENKEN-HIGHDENTAL Co.,Ltd.

130 Ishigohri-cho, Ohyake, Yamashinaku, Kyoto 607-8187, Japan

TEL 81-75-571-1000 FAX 81-75-572-9000

e-mail : denken@kdf.co.jp