

INSTRUCTION MANUAL

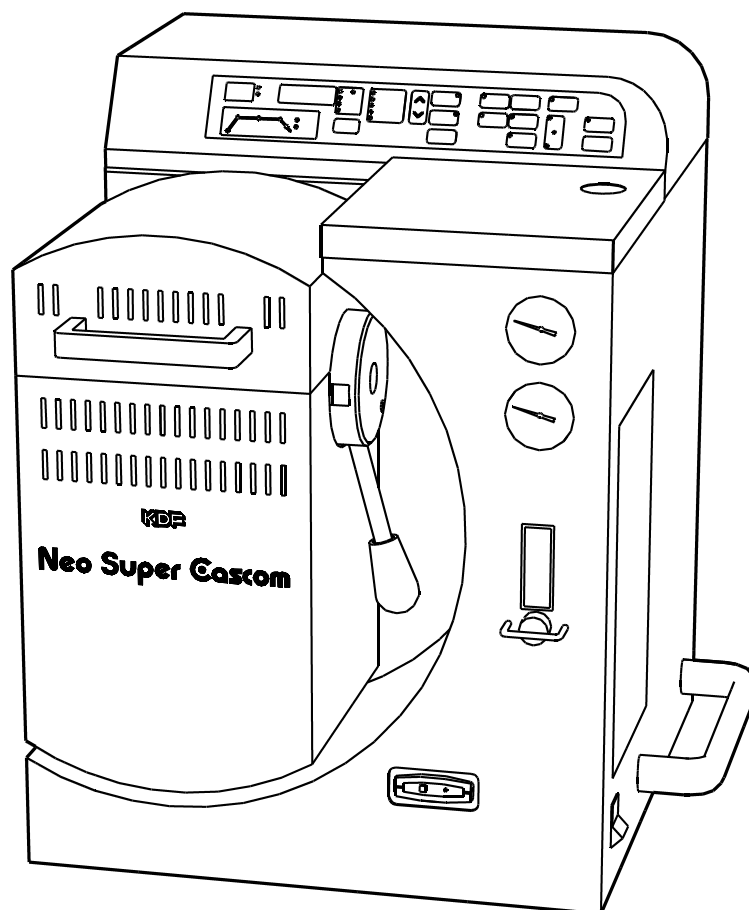

Neo Super Cascom

Before using the KDF Neo Super Cascom, please read the manual thoroughly and understand the capabilities and proper usage for this machine. Technical hints and tips regarding casting are covered in the separate "Casting Manual". Please keep these manuals in an easily accessible location for future reference.

Contents



Safety Precautions	P1
Standard Accessories	P4
Descriptions of Component Parts	P5
Front View Parts and Descriptions	P5
Back View Parts and Descriptions	P6
Operation Panel and its Functions	P7
Preparations before Use	P8
Power Requirement	P8
Location & Environment	P8
Compressed Air Piping	P8
Argon Gas Piping	P8
Vacuum Pump Connection	P8
Pocket Pager Installation	P9
Power On	P9
Stand-by Mode	P9
How to Program	P9
Programming on Auto Program Mode	P10
Programming on Manual Program Mode	P11
Program Check and Modification	P12
Melting Mode	P12
Installing Carbon Washer	P12
Melting with Ceramic Crucible	P13
Melting with Carbon Crucible	P14
Other functions while the unit is in melting mode	P14
+TEMP	P14
Melt Check	P14
Melting with Argon Flow	P14
Casting Mode	P14
Program Duplication Mode	P15
Default Value Set Mode	P15
Chime Volume	P15
+TEMP Heat Increase	P16
+TEMP Increased Heat Memory	P16
Altitude Set	P16
Temp Unit Measure Set /°F	P16
Muffle Heat Correction	P16
Life Span of Ceramic and Carbon Crucible	P17
Pocket Pager	P17
STOP Button	P18
Periodic Machine Cleaning	P18
Retort	P18
Muffle Chamber	P18
Chamber Lid Seal Ring	P18
Exhaust Air Filter Check	P18
Drain Filter Check	P19
Lock Lever	P19
Maintenance of Muffle	P20
Consumables	P20
Trouble Shootings	P21
Error Messages	P22
[HERE] is displayed	P22
Main Specifications	P23

Safety Precautions

We recommend you to follow these instructions for proper use.

The safety precautions contained herein and the accompanying icons are provided for the safe use of this machine and to prevent injuries and loss on material resources. Please read them carefully prior to your actual machine operation. It is recommendable that working on the unit should not be attempted by anyone who is not well-informed of the precautions necessary for machine operation.

Reference pages of the related topics in this manual are illustrated with arrow marks (i.e. P12)

 WARNING	Failure to follow or of the directions may cause severe injury or death.
 CAUTION	Failure to follow or ignorance of the directions may cause injuries or damages to material properties.

Examples of Precaution Icons



This mark requires to pay attention to the caution mark as shown inside or around it. The illustration on the left means to exercise caution for shock hazard.



This mark means prohibited actions. Prohibited action mark(Do not disassemble)is shown inside or around the mark.



This mark means forced action and directions to follow. Instruction to follow is shown (Unplug out of power outlet) inside or around the mark.

WARNING



Unplug

In the event when there is smoke, abnormal odors or sounds, unplug immediately and contact the dealer for repairs. Continued use may cause electric shock or fire. We recommend you not to attempt repairs yourself.



Unplug

In the event when water or debris enters the machine, unplug immediately and contact the dealer for advice. Continued use may cause electric shock or fire.



Unplug

In the event when the machine is dropped or the furnace frame is dented, unplug immediately and contact the dealer for advice. Continued use may cause electric shock or fire.



Do Not
Disassemble

Do not remove the panels or parts uninstructed or modify them in any manner. Some of the parts inside are high voltage and contact with them may cause fire or electric shock. We recommend you to contact the dealer for repairs or machine checks.



Not Designated
Volt. Prohibited

Plug to the power outlet of the designated voltage described in the main specifications. Use of any other voltage may cause fire or shock.



Prohibited

Place the machine so that there is adequate space from walls or other equipment.

- Keep distance of more than 8 inches from peripheral equipment and surrounding walls and 5 feet up from ceiling.
- If the appropriate distance can not be secured, we recommend you to place the insulator to prevent fire.

CAUTION



Prohibited

Do not use or place anything flammable near the machine. Fire or burns may result.



Check Before
Use

Check the machine for signs of parts damage prior to use and make sure the unit is in normal state. Contact the dealer for advice when you find anything abnormal.

CAUTION



Required

Plug the main power cord into power outlet completely. The plug may heat up and cause fire or burns if not completely plugged in. In addition, if the metal part of plug is touched while the plug is not fully plugged in, electric shock may result.



Prohibited

Do not place the machine on an unstable base to prevent the machine from falling and damaging. This may cause injury.



Unplug

Unplug the main power cord from the power outlet when the machine is not in use for a long period of time.



Prohibited

When you unplug the power cord from the power outlet, do not pull the cord. If the cord is damaged, fire or shock may result. Always remove by handling the plug.



Unplug

In case of a periodic machine maintenance, unplug the power cord from the power outlet. Do not handle the plug with wet hands. This may cause electric shock.



Prohibited

Do not place heavy items or place machine on the power cord and make sure that the cord is not pulled too tightly and is not damaged. This may cause fire or electric shock.



Wet Handling
Prohibited

Do not handle the machine with wet hands as this may cause electric shock.



Prohibited

Do not insert red hot crucible into the crucible counter. This causes the trouble.



Prohibited

This machine is for dental casting. We do not recommend you to use the machine for any other purpose.

Standard Accessories

When you unpack the machine, we recommend you to make sure that the following standard accessories are received. In addition, please check the machine for any damage or dent on the unit surface. Contact the dealer should there be any damage on the unit.

View Glass	1pc	A shaded viewer to facilitate the checking of alloy melting situation.
Tweezers	1pair	Used to move crucibles in and out of muffle. Reverse spring type.
Crucible Stand	1pc	Stainless steel crucible holding stand.
Carbon Washer	10pcs	Gray colored washer and used with crucibles P12
Washer Guide	1pc	Used to install carbon washer onto crucibles P12
Carbon Crucible S.CAS	3pcs / Box	
Ceramic Crucible N.S.C	3pcs / Box	
Casting Rings 1 3/4"diam.(43mm)	1pc	
2 3/8"diam.(60mm)	1pc	
3"diam.(76mm)	1pc	
3 1/2"diam.(90mm)	1pc	
Sprue Formers 1 3/4"diam.(43mm)	1pc	
2 3/8"diam.(60mm)	1pc	
3"diam.(76mm)	1pc	
3 1/2"diam.(90mm)	1pc	
Crucible Former	2pcs	Used for ringless casting
Piping Tube 16feet(5 m)	1pc	Used for compressed air/argon gas tank P8
Pocket Pager	1pc	A chimer to let you know casting timing P17
Dust Collector	1pc	Used to clean debris and dusts out of muffle chamber P18
Instruction Manual	1booklet	Operation manual with precautions for safe and proper uses of the Neo Super Cascom unit
Casting Manual	1booklet	Instruction and tips on casting technique for the Neo Super Cascom unit.

We recommend you to save the carton and all packing materials for future use when there is ever a need to ship or move your equipment.

Descriptions of Component Parts

Front View Parts and Descriptions

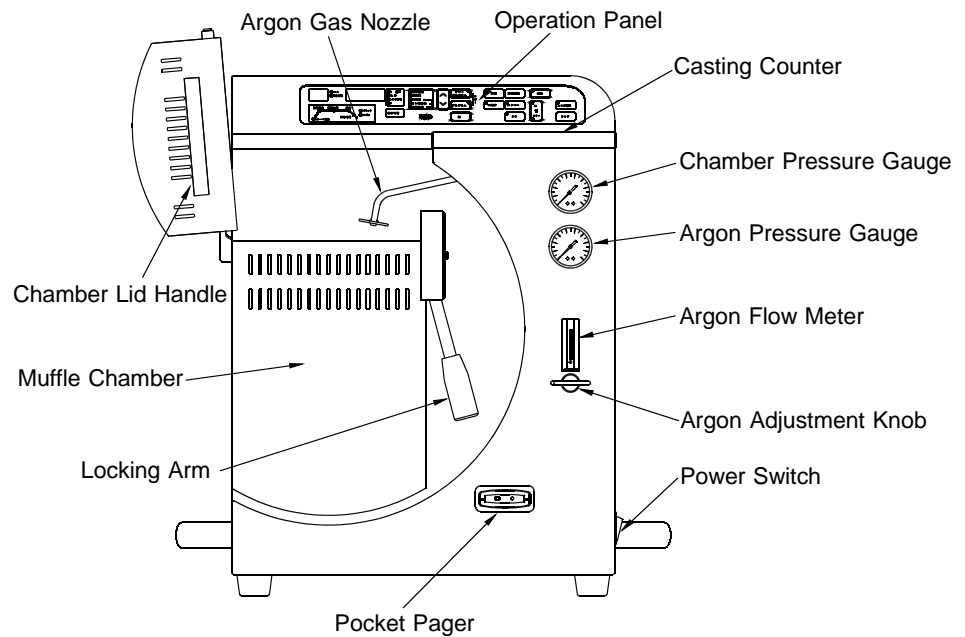

Chamber Lid Handle	Used to open and close the chamber lid by hand. Note) Be slowly when you open and close the chamber lid. Quickly repeated movement will cause the trouble.
Muffle Chamber	Used to house furnace muffle to heat up and melt casting alloys.
Locking Arm	Used to lock chamber lid when in casting process.
Argon Gas Nozzle	Used to blow argon gas into crucible to prevent oxidation of alloy during melting process. The argon button on the operation panel controls the nozzle in and out. This nozzle is also available for covering crucible opening without flowing argon gas.
Operation Panel	The storage of programs and casting operation and other controls are available.
Casting Counter	A device to count the numbers of castings done of a ceramic crucible. P13
Chamber Pressure Gauge	Displays chamber pressure. Vacuum and air pressure is displayed.
Argon Pressure Gauge	Displays the pressure of argon gas tank connected.
Argon Flow Meter	Displays the flow of argon gas from argon nozzle shown in the unit measure of liter per minute.
Argon Adjustment Knob	Adjusts the flow of argon gas. Turn left to flow more and turn right to flow less.
Power Switch	On/Off power switch with current breaking function.
Pocket Pager	A beeper to let you know of status up to the end of alloy melting cycle. P17

Back View Parts
and Descriptions

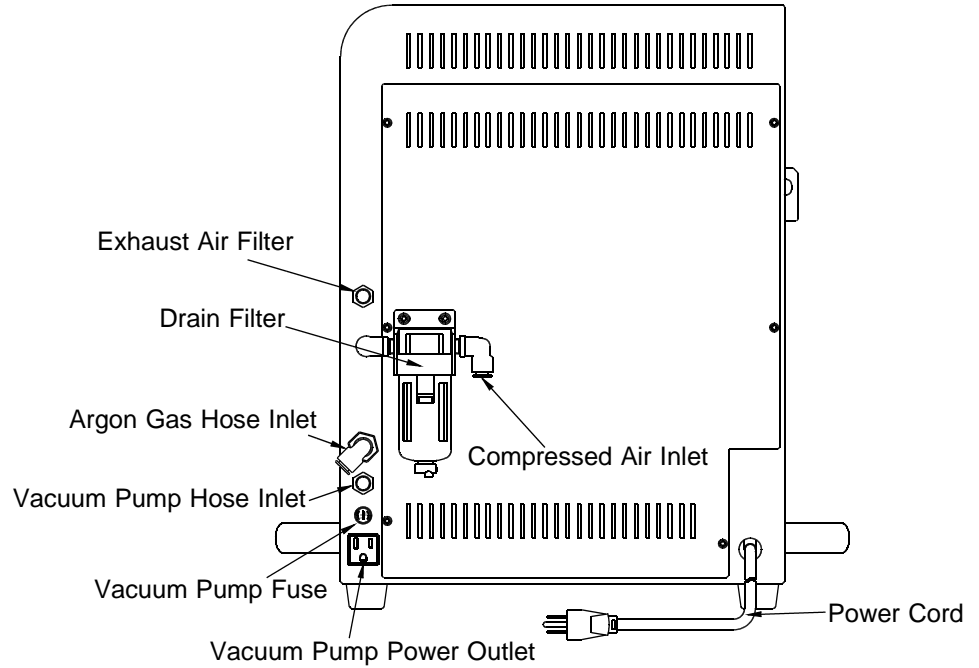

Exhaust Air Filter	A port to release pressure from chamber when you perform casting. Periodic cleaning is recommended. P18
Drain Filter	Used to prevent rust, dust, moisture etc. out of compressor from entering the unit. Periodic cleaning is recommended. P19
Compressed Air Inlet	Connect one end of the air hose provided and the other end to the nearby compressed air source. P8
Argon Gas Hose Inlet	Connect the hose provided to a low pressured argon gas tank with a gas regulator for argon pressure and argon melting atmosphere. P8 If argon pressure and argon melting atmosphere is not going to be used, then the connection is not necessary.
Vacuum Pump Hose Inlet	Used to connect a hose to vacuum pump (optional). P8
Vacuum Pump Fuse	A fuse against over power flow to vacuum pump (optional).
Vacuum Pump Power Outlet	Power outlet for vacuum pump (optional).
Power Cord	Main power cord for the unit. A dedicated power outlet with grounding is recommended to use.

Operation Panel and its Functions

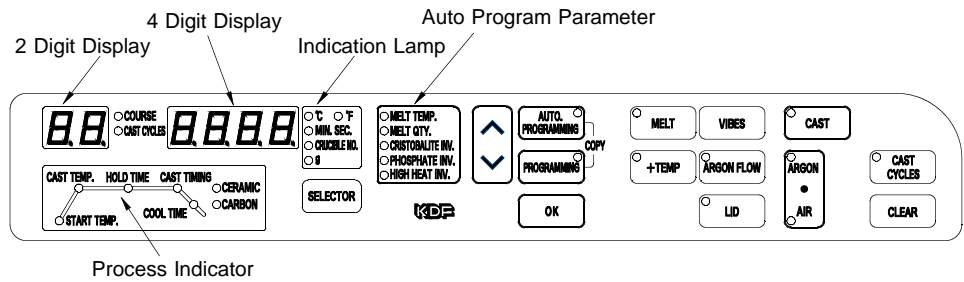

2 Digit Display Displays parameters such as current program course number, casting count of ceramic crucible and original program course that you want to duplicate.

4 Digit Display Displays unit of measure for each indication shown on the display.

Process Indicator Displays program items while you store a program and displays the relevant process during melting or casting operation.

Indication Lamp Each lamp is illuminated in conjunction with the indication.

SELECTOR Button Press the button to change the indication on display.

Auto Program Parameter Programmable items used in the auto program mode.

[] Button Press the button to move the program item or to increase or decrease program value.



While you hold down the button, the values change rapidly.

AUTO. PROGRAMMING Button Alloy liquid phase temp, alloy quantity, investment type and crucible type are programmable to store automatically each necessary program parameters.

P10

Note) This program mode enables you to store Start Temp, Melt Temp, Melt Time, Cast Timing and Cooling Time.

PROGRAMMING Button Used to directly program, modify or check the 5 program parameters. And the simultaneous press of the Auto Program Button and the Program Button allows you to duplicate program. P15

OK Button Press to save the stored program value or to shift to next program parameter while in program mode.

MELT Button Press to enter alloy melting mode. P12
Repress the button to release melting mode.

+TEMP Button Press the button while in melting mode to increase additional heat to the set melt temp.



• When alloy is not sufficiently melt at the set temp, this mode enables you to add heat without returning to the program mode. P14

• The set default value 20 °F (10 °C) is modifiable and to save or not to save the modified default value are at your choice. P16

VIBES Button Press the button to give a slight vibration to the chamber and to make sure of the alloy melting situation. P14

Note) We recommend you to use the view glass provided when you check the melting situation.

ARGON FLOW Button	Click the button rapidly twice to engage the argon gas nozzle and flow argon gas during melting. Argon flow meter checks the gas flow amount.
LID Button	Click the button rapidly twice to engage the argon gas nozzle without the flow of argon gas. Press the button once to disengage the nozzle.
CAST Button	Press the button after locating casting ring in place to start casting.
ARGON · AIR Button	Press the button to choose between argon gas and pressurized air applicable for casting. Double click the button to change to either Ar. or Air pressure mode to avoid mistake in operation.  Hint Argon pressure will prevent alloy from oxidation and will help you grind cast alloys in shorter time.
CAST CYCLES Button	Press to show the casting cycles used of the ceramic crucible inserted in crucible counter. The number of casting cycle is shown on the 2 digit display. P13
CLEAR Button	Press the button to clear a ceramic crucible number from memory.

Preparations before Use

Power Requirement	We recommend you to use the proper power voltage described in the main specifications of this unit.
Location & Environment	<ul style="list-style-type: none"> • Set up the unit on the center of a flat stable table • Keep the unit away from walls and other equipment <p>Note) We recommend you to set up your furnace 8 inches off the surrounding walls and 5 feet off lab ceiling and do not place any thing flammable near the furnace. If the appropriate distance from each periphery can not be secured, we recommend you to place the insulator on each wall and ceiling to prevent fire.</p>
Compressed Air Piping	<p>Connect air pressure hose provided to the compressed air inlet (Ref. drawing on the right) and connect to compressed air tank.</p> <p>Note) Keep the hose length possibly short to decrease the flow resistance within hose to a minimum.</p> <p>Note) Keep the pressure between 0.5 and 1MPa (73 ~ 145 psi).</p> <p>Note) Place the hose in a secure location where it will not get stepped on or tripped over.</p>
Argon Gas Piping	<p>Connect the argon gas hose provided to the argon gas inlet (Ref. drawing on the right) and connect to argon gas tank with pressure regulated between 0.7 ~ 0.8MPa (102 ~ 116 psi).</p> <p>Note) In case of argon pressure, use of a regulator is required to control the flow of over 30 cubic meters/hour at the pressure of 0.8MPa(116psi). We recommend you to use our optional pressure regulator provided to avoid occasional miscasting.</p> <p>Note) Keep the hose length as short as possible to decrease the flow resistance in the piping.</p>
Vacuum Pump Connection	<p>Plug the vacuum pump to the pump power outlet as shown on the right drawing. Connect the vacuum pump hose to the hose inlet.</p> <p>Note) We recommend you to use our optional vacuum pump, DDP-40 or KD-VP. The use of a vacuum pump other than that of KDF brand may not work effective machine functions and may even cause machine malfunctions.</p>

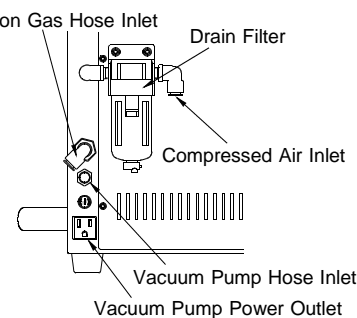

Pocket Pager Installation

Insert the pager provided into the slot located on the front bottom right side of the unit. Insert with magnet side in. The top/bottom configuration is not important.

Note) There is a magnetic latch inside the slot. Make sure to insert fully and engage the magnetic latch.

Power On

Turn the power on after machine setup.

1. Turn the switch on the front right side of the unit upward to power on. After **SCRS** is displayed, an existing muffle temperature appears to show the unit is in correct condition for operation.

2. The READY lamp of pager will blink to charge the pocket pager. With the pager fully charged and the unit in melting mode, the lamp is illuminated when time data up to the end of melting is stored in the pager. P17

Note) Even after the pager is fully charged, the lamp will continue to blink if melt button is not pressed.

Note) If the pager battery is completely discharged, the lamp will take approx. 10 seconds before it starts blinking.

3. If the Start Temp has been programmed, it will start heating up toward the Start Temp.

THIS IS CALLED STANDBY MODE

Note) At low temperatures the unit may make a low buzzing sound during heat up. This is the sound electricity flowing through muffle heater. This is normal.

Note) If **ERR** is displayed on the 4 digit display, open the chamber lid to prevent the chamber lid from overheating.

Stand-by Mode

The following modes are available to be switched from Standby Mode.

1. Program Mode

Casting parameters are programmable in both auto and manual program mode. Program checks and modifications are also available.

2. Melting Mode

Alloy melting mode for casting.

3. Casting Mode

Cast melted alloy into a mold.

4. Duplication Mode

Enables you to copy the program on display to other program course desired. This will help simplify the creation of similar program.

5. Default Value Set Mode

Enables you to set Pager sound volume, +Temp value and Altitude.

We will cover each mode as described below.

How to Program

Two methods of programming are provided as follows ;

1. Auto Program Mode

The inputs of alloy liquid phase temp, alloy quantity, investment type and crucible type will automatically program the 5 casting parameters.

Note) This auto program mode is not 100% infallible. Depending on castings at hand when you are in need of adjusting each parameter, we recommend you to make adjustments to the parameters as required on the manual program mode.

2. Manual Program Mode

This mode is to input each parameter necessary for casting by hand.

Programming on Auto Program Mode

Using the auto program mode, we will program the following parameters on the program course No.15 to store.

Ex. Porcelain bonding precious alloy

Liquid phase temp. 2084 °F (1140)

Alloy melt quantity 30g (1.1 Oz.)

Investment type Phosphate

Crucible type Carbon

- Program Course
1. Press the button to bring the course display to read .
Keep pressing the button to scroll through numbers quickly.
 2. Press the button.
The lamp of Auto Program is illuminated and the lamp of Liquid Phase Temp. is blinking.
- Liquid Phase Temp.
3. Press the button to display and press the button.
The lamp of Alloy Melt Quantity is blinking.
- Melting Quantity
4. Press the button to display and press the button.
- Investment Type
5. Press the button to select Phosphate and press the button.
 **Hint** Press the button repeatedly to scroll through each parameter quickly and to check program or to modify.
- Crucible Type
6. Press the button to choose Carbon crucible and press the button.
 7. After storing the correct 4 parameters, press the button to occur the 6 necessary casting parameters from the 4 parameters stored and the unit stores the data in the memory course No.15.
The Start Temp. lamp blinks and the unit will start to heat up to the Start Temp.
- Note) If is displayed, the chamber lid is closed. Open up the chamber lid.
- Note) When you do not continue further casting, we recommend you to turn the power off or to select a blank programmed course, otherwise the unit will unnecessarily continue heating up to the start temp.
- Note) When you desire to confirm or modify the stored 6 casting parameters, we recommend you to refer to the next program mode of 「 Programming on Manual Program Mode 」.
- Note) If any one of the parameters is missing in programming, the parameters will not store the program.

Programming on
Manual Program Mode

Using the manual programming mode, we will program the following parameters on course No.24 to store the example.

Ex. Co-Cr Alloy for Metal Plate

Star Temp.	2282 °F (1250)
Melt Temp.	2660 °F (1460)
Melt Time	6 min. 0 sec.
Cast Timing	- 0.3 sec.
Cooling Time	2 min. 0 sec.
Crucible	Ceramic

- | | |
|-------------------------|---|
| Program Course | 1. Press the <input type="button" value="24"/> button to adjust the course display to read <input type="text" value="24"/> . |
| | 2. Press the <input type="button" value="PROGRAMMING"/> button.
The Program lamp is illuminated and the Start Temp. is blinking. |
| Start Temp. | 3. Press the <input type="button" value="2282"/> button to display <input type="text" value="2282"/> and press the <input type="button" value="OK"/> button to store the Start Temp.
The lamp of Melt Temp is blinking. |
| Melt Temp. | 4. Press the <input type="button" value="2660"/> button to display <input type="text" value="2660"/> and press the <input type="button" value="OK"/> button to store the Melt Temp.
The lamp of Melt Time is blinking. |
| Melt Time | 5. Press the <input type="button" value="6.00"/> button to display <input type="text" value="6.00"/> and press the <input type="button" value="OK"/> button to store the Melt Time.
The Cast lamp is blinking. |
| Cast Timing | 6. Press the <input type="button" value="-0.3"/> button to display <input type="text" value="-0.3"/> and press the <input type="button" value="OK"/> button to store the Cast Timing.
The lamp of Cooling Time is blinking. |
| Cooling Time | 7. Press the <input type="button" value="2.00"/> button to display <input type="text" value="2.00"/> and press the <input type="button" value="OK"/> button to store the Cooling Time.
The selection lamps of crucible type are blinking. |
| Choice of Crucible Type | 8. Press the <input type="button" value="Ceramic"/> button to choose the desired crucible type.
We recommend you to refer to the casting manual provided for advice which type of crucible to use with your alloy.
(Note) The maximum temperature programmable for carbon crucible is 2642 °F (1450). |
| | 9. Press the <input type="button" value="OK"/> button to store the program and program check is available. If you find any error in the program storage, the error is modifiable in the same program method listed above. |
| | 10. Once the correct program storage is confirmed, press the <input type="button" value="PROGRAMMING"/> button to exit the Manual Program Mode.
The lamp of Start Temp is blinking and the unit is heating up toward the Start Temp.
(Note) When you do not continue further casting, we recommend you to turn the power off or to select a blank programmed course, otherwise the unit will unnecessarily continue heating up to the start temp.
(Note) If <input type="text" value="- 9 -"/> is displayed when you exited the manual program mode, one of the program parameters stored is invalid. The relative invalid program parameter on the process indicator will blink and we recommend you to correct the invalid program as described in the 「 Program Check and Modification 」 below. |

Program Check and Modification

The stored program check and modification are available in the following manner.

1. Press the button to choose the desired course number that you want to check or modify.
2. Press the button and the lamp of the Start Temp. on the Process Indicator will blink and Start Temp. appears on the 4 digit display.
3. Press the button to modify the stored value and press the button to enter.
4. Press the button to shift to the next parameter for program check or modification in the same way as described above.



If you turn the power off during Program Mode, this will prevent the unit from saving any change. If you accidentally entered Program Mode or modified in error, turn the power off as it is.

Melting Mode

This mode is for melting the alloy in crucible to prepare for casting.

Turn the power on and press the button to choose the casting program course. The Start Temp lamp will blink and temperature is heating up toward Start Temp. When the Start Temp is reached the lamp will stop blinking and is illuminated.



Considering the life of muffle heater, when the muffle heat is below 212 °F (100 °C), the unit restricts speedy heat rise.

Note) When you melt alloy make sure to use the crucible of which lamp is illuminated on the Process Indicator. If wrong crucible is used, is displayed to fail the melting and the cast cycle numbers will add in spite that ceramic crucible is not being used.

Installing Carbon Washer

To prevent alloy and debris from entering the retort through the gap between crucible and retort, the installation of carbon washer is recommendable in the manner as shown in the sketches.

1. Place a carbon washer in the washer guide from under.
2. Stand a crucible bottom-side up and bring down the washer and guide together to install.
3. Push the washer down to a distance of approx. 3mm from the crucible lip.
4. Remove the guide from the washer and crucible.

Note) Do not cast with the guide installed on the crucible.

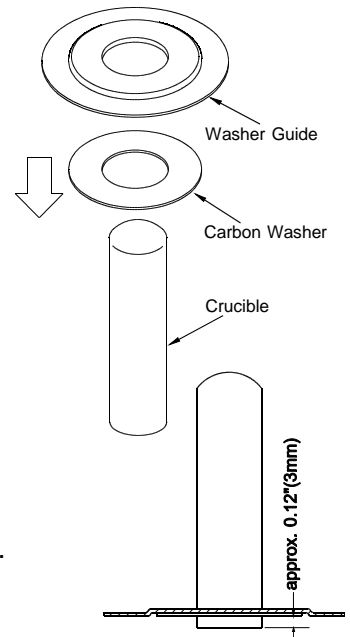

Melting with Ceramic Crucible



When you melt alloy and cast using a ceramic crucible, we do not recommend you to use the ceramic crucible over the maximum allowed casting cycles.

Do not insert red hot crucible into the crucible counter. This causes the trouble.

Check Casting Cycles

1. Use the reverse tongs provided to grip the inside of ceramic crucible and set the crucible in place to press the **CAST CYCLES** button.
2. The displays will show **--** **----** while the crucible rotates for approx. 10 seconds to read the bar code on the crucible. The 4 digit display shows the crucible No. and the 2 digit display shows the cast cycles of the crucible already used.
3. If the cast cycles are over the maximum allowable limit, the numbers of cast cycles used and **--** will appear alternately on the 2 digit display. As we do not recommend the continued use of the crucible that exceeded allowable cycles, replacement of crucible is recommendable and repress the **CAST CYCLES** button.

Note) If you accidentally check a wrong crucible other than the one you intended to use, press the **CLEAR** button and press the **CAST CYCLES** button after inserting a correct crucible. If you melt alloy with a different crucible than the one you checked, the cycle numbers will be added to the unused crucible. And if the cycle numbers exceeded unnoticedly, the continued use of the crucible may have a crack.

Note) If you use a crucible with no bar code or you don't check cycle numbers or check with a carbon crucible and you press the Melt button, **no HEE** is displayed and the unit will not go into melting mode in the course where ceramic crucible should be used.



If the same crucible is used consecutively for melting, there is no need to do the crucible check repeatedly. The unit will automatically recognize it as the same previous one used for casting.

Crucible Cycle Number

The unit keeps memory of crucible cycles used and crucible number and cycle numbers are recorded at each melting and a ceramic crucible is available up to 10 cycles of castings.

- A ceramic crucible cycle is counted as follows ;
Melt temp over 2552 °F (1400) is counted 1 cycle and below 2552 °F (1400) 0.5 cycle.
Accordingly, for example, 2 digits cycles may be displayed like **6.5** cycles.

Note) In case of the cycles 9.5 recorded, further casting in melt temp. over 2552 °F (1400) is not acceptable and when you press the Melt button, the display will show **9.5** and **--** alternatively. However, if melt temp is below 2552 °F (1400), the crucible will be used one last cycle.

Melting

4. After checking the ceramic crucible, insert the alloy into the crucible to place it into muffle and press the MELT button.
5. Once Cast Temp. is achieved and Hold Time is elapsed, chime will sound to notify that the alloy is ready for casting.

Note) When Hold Time is held for 15 minutes after Hold Time is finished, the heater will turn off and **FAIL** is displayed for safety reason.

We recommend you to make visual checks of ceramic crucible before use for surface cracks or the crucible is malformed or not, regardless of its restricted cycles. If anything abnormal found, do not use the crucible.

Melting with
Carbon Crucible

- When you use carbon crucibles, there is no need to check the cycle count.
1. Insert alloy into a carbon crucible and set the crucible into muffle in place to press the MELT button.
 2. Once Cast Temp is achieved and Hold Time is over, chime will sound to notify that the alloy is ready for casting.

Other functions while the unit is in melting mode

+ TEMP

(Functions in common for both ceramic and carbon crucibles)

- Once the Cast Temp is reached, press the **+ TEMP** button to increase by an amount of temperature set in the default value. P16
- It is available to save the above increased temp in the program contents or to use the temp only once for the current program. P16

Melt Check

- Press the **VIBES** button to slightly shake the muffle and to facilitate the viewing of alloy melting situation.

Note) When you check the alloy melting situation, we recommend you to wear safety goggles and use the view glass provided. There is a slight chance that melted alloy may splash out and viewing the alloy melted at high heat may affect your eyesight.

Melting with Argon Flow

Argon gas is useful for preventing alloy oxidation and effective for extending the life of carbon crucible.

- Double click the **ARGON FLOW** button and the argon nozzle engages to inject argon gas from the tip of the nozzle into the crucible with alloy. Repress the **ARGON FLOW** button once to disengage the nozzle.
- Argon flow is adjustable with the knob on the Argon Flow meter to set amount of flow. The flow amount of 1 ~ 2 liter/min is ideal.



Double click the **LID** button to draw out the argon nozzle but argon gas is not injected. This function will come in useful for avoiding heat emission and for shortening melting time. This will also help for longer life of carbon crucibles.

Casting Mode

Once the Hold Time is over, a chime will sound 6 times. Be ready to set casting ring in place to start casting operation. Choose your option in advance for the type of pressure for casting, compressed air or argon gas.

- Place a casting ring on the top of muffle.

Note) Place the ring on the center of the metal plate to fit with one of the circles on the plate.

Note) When the muffle inclines, return the muffle to vertical position before press the cast button.

- Close the chamber lid and move the locking arm down to lock.
- Press the Cast button immediately.
- Vacuum pump will work to create vacuum in the chamber.
- When the programmed vacuum level is reached, the chamber inverts to apply pressure.
- While the chamber being inverted with cooling time over, the pressure inside the muffle is released and the chamber returns to its original position.
- Return the locking arm to the original position to open the chamber lid and remove the casting ring and crucible.

Program Duplication Mode

This function is used when you want to copy a program to another program memory slot. The following example shows to transfer the program on course 12 to course 25.

Select Original Program

1. Press the button in stand-by mode to display course .
2. Press the and button simultaneously.
 - The lamps of the and the buttons will turn on and off.
3. The 4 digit display will read . Press the button to change the display to read . CP means Copy.
4. Press the button to activate program copy and displays the course 25 to finish program copy.

Note) If no button press done for approx. 10 seconds, the unit returns to stand-by mode to release the duplication mode.

Default Value Set Mode

Press the button while you hold down the button and (initial) is displayed briefly to enter the default value set mode that includes the following value settings.

1. Chime volume level of notification and warning when button is pressed.
2. Temp increase set when the +TEMP button is pressed.
3. Choice of the increased melt temp to save in the program or not.
4. Altitude of unit location setting.
5. Set of temperature unit of measure (/ °F)
6. Muffle Heat Correction

Chime Volume

- Button entry volume

The chime level set of button entry is available.

Display (Default Value)

Press the button to display the desired value on the 4 digit display and press the button to enter and to shift to the next program parameter.

<input type="text" value="b1"/>	<input type="text" value="0"/>	: Mute
<input type="text" value="b1"/>	<input type="text" value="1"/>	: Low
<input type="text" value="b1"/>	<input type="text" value="2"/>	: Medium
<input type="text" value="b1"/>	<input type="text" value="3"/>	: High

- Error and Finish chime volume

Display (Default Value)

Press the button to display the desired value on the 4 digit display and press the button to enter and to shift to the next program parameter.

<input type="text" value="b2"/>	<input type="text" value="0"/>	: Mute
<input type="text" value="b2"/>	<input type="text" value="1"/>	: Low
<input type="text" value="b2"/>	<input type="text" value="2"/>	: Medium
<input type="text" value="b2"/>	<input type="text" value="3"/>	: High

• Other chime volume

Finish chime of Hold Time and Power On entry chime volumes are available to set.

Display (Default Value)

Press the button to display the desired value on the 4 digit display and press the button to enter and to shift to the next program parameter.

<input type="text" value="b3"/>	<input type="text" value="0"/>	: Mute
<input type="text" value="b3"/>	<input type="text" value="1"/>	: Low
<input type="text" value="b3"/>	<input type="text" value="2"/>	: Medium
<input type="text" value="b3"/>	<input type="text" value="3"/>	: High

+TEMP Heat Increase

Press the button to adjust the default temperature.

Display (Default Value 20 °F (10 °C))

Press the button to adjust heat increase within 1 ~ 90 °F and press the button to shift to the next program parameter.



If temp unit measure is set in , the default value and heat increase should read 10 and 1 ~ 50 respectively in Celsius.

+TEMP Increased Heat Memory

The above increased melt temp by the +TEMP button is available to save (yes) on the program or not (no).

Display (Default Value no)

Press the button choose yes or no and press the button to shift to the next program parameter.

Altitude Set

We recommend you to set the altitude above sea level according to the place to locate the unit.

Display (Default Value)

Referring to the followings, press the button to set the altitude.

Press the button to shift to the next program parameter.

0 ~ 1640feet(500m)	<input type="text" value="500"/>
1643feet(501m) ~ 3280feet(1000m)	<input type="text" value="1000"/>
3284feet(1001m) ~ 4921feet(1500m)	<input type="text" value="1500"/>
4925feet(1501m) ~ 6562feet(2000m)	<input type="text" value="2000"/>

Temp Unit Measure Set / °F

The option to display the unit of measure in Celsius or in Fahrenheit is available.

Display (Default Value Fahrenheit)

Press the button to change the unit of measure. is meant to show in Celsius. Press the button to shift to the next program parameter.

Note) Repeated changes of unit of measure may not be able to convert back to the original temp due to the processing of temperature calculations inside the unit.

Muffle Heat Correction

When you have replaced a muffle, heat correction of the new muffle is adjustable. The heat correction value is shown on the muffle replacement procedure attached to the muffle.

Display (Heat Correction value of the current muffle)

Press the button to set the correction value instructed.

The values are ranged within - 50 ~ + 50 to set.

Press the button to return to 「Chime Volume Set Mode」.

Press the Selector button to release the default value set mode and the unit will return to stand-by mode.

Life Span of Ceramic and Carbon Crucible

Ceramic Crucibles

Ceramic crucibles are mainly used for melting Co-Cr alloys, Ni-Cr alloys and Palladium (Pd) for porcelain bonding alloys that require high melting temperature. The ceramic crucible life is variably affected by the type of alloy, melting temperature and melting time. Despite of melting under the identical use, each individual ceramic crucible may differ in its life due to the feature of ceramic. When melting alloys, visual check for cracks and deforms of crucibles are recommendable. We do not recommend you to use the crucibles that are cracked or deformed.

Carbon Crucibles

Compared to ceramic crucibles, carbon crucibles are mainly used for melting silver alloy, gold alloy, gold/silver/palladium alloy, precious alloy for porcelain bonding and semi-precious alloy that require comparatively lower melting temperature. When melting alloy, the shield gas emitted from carbon suppresses the oxidation of melted alloy and carbon crucibles are slowly consumed.

As a general mark, when you see the crucible height is shortened and the crucible opening is sharpened as shown on the sketch, replacement of crucible is recommended and do not use a crucible with holes or cracks.

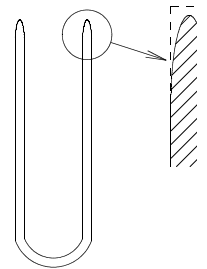

Alloy melting with argon gas or covering the crucible opening with the nozzle head will delay the wear of the crucible opening exposed to air. P14

Pocket Pager

When melt time is finished, this device will beep to inform ceramist away from the unit of casting timing (finish of hold time).

1. Plug the pocket pager into the slot on the front of unit and the lamp will blink.

Note) Even if the pager is completely discharged, it may take more or less 10 seconds for the charge lamp to begin blinking. This is normal.

2. When you press the melt button and the unit is in melt mode, the pager receives time data until the melt time finish (casting).
3. When the pager duly receives the time data, the lamp is illuminated.

Note) Even after the lamp is illuminated, the lamp will dim at 1 second intervals. This is because the pager receives updated information from the unit. This is normal.

4. Once the lamp is illuminated, push the pager to remove it. This will not give any mechanical trouble.



- If the built-in battery is fully charged and the pager is programmed with correct data, the pager beeps for a second when the pager is removed from the pocket. The pager, being not operated with signals, works even when remote from the unit.

- When not in use, we recommend you to keep it plugged into the pocket. You can remove the pager any time after you pressed the melt button.

Note) There is no worry of overcharging the pager.

5. Preliminary chimes sound from 5 minutes before casting time at 1 minute intervals.

5 chimes before 5 minutes, 4 chimes before 4 minutes, chimes of the remaining minutes sounding at 1 minute intervals.

6. When melt time is over and the unit is ready for casting, the pager will give 6 chimes.

	<p>7. After that, the pager will chime 3 times at 10 seconds intervals to urge casting operation.</p> <p>8. If the STOP button is not pressed within 15 minutes of cast chime, the pager will cease operating.</p>
STOP Button	<ul style="list-style-type: none"> • A temporary stop of preliminary chime While the preliminary chime is sounding, press the STOP button quickly to stop the chime. • Stop all chimes Keep pressing the STOP button for over 1 second and an entry beep sounds to stop all chimes.

Periodic Machine Cleaning

In order to maintain the capacity of this unit further longer the following periodic cleanings prior to use are recommended.

Note) When you perform machine maintenance, make sure that the unit is turned off and the muffle heat is as low as room temperature to avoid the cause of fire and electric shock.

Retort Make sure to find if melted alloy is stuck to the retort bottom or not and if the retort has any crack or not.

Melted alloy stuck to the bottom of a retort will react to the retort under high heat and can make a tiny hole or a crack for the melted alloy to leak and will attack the muffle heater to damage. We recommend you to replace it with a new retort.

Muffle Chamber When the chamber turns upside down for casting operation, metal debris and etc. in the muffle may result in miscasting or may attack muffle heater to cause heater breakdown. We recommend you to use a vacuum cleaner or the dust collector provided referring to the following recommendations.

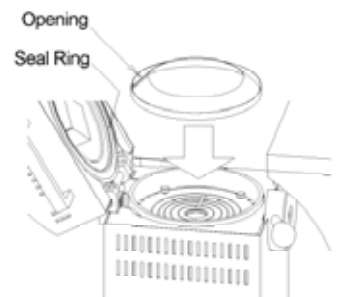

1. Open up the chamber lid and install the dust collector with the opening to the left side on the top of muffle.

Note) Press down the dust collector provided to come in contact with the surface of metal plate.

2. Close the chamber lid to invert the chamber by your hand 180 degree and then return the chamber to the original position.

3. Open up the chamber lid again to lift up the dust collector as horizontal as possible and throw away the collected debris.

Chamber Lid Seal Ring The dirt on the seal ring may not allow you to reach sufficient vacuum level or vacuum may leak during pressure application. Use a clean wet cloth to wipe the dirt on the seal ring before casting operation.

Exhaust Air Filter Check The exhaust air filter on the back of the unit is for silencing of the release of pressurized air when the unit operates casting. Make sure to check the filter and when the filter is shaded in black, replacement with a new one is recommendable.

Drain Filter Check

Press the button at the bottom of drain filter (marked on the right) to drain the moisture gathered inside the drain filter. We recommend you to drain the moisture each time before using the unit, regardless of the amount of moisture collected. If you use the unit with the moisture collected over the allowable level, the moisture will come in contact inside the unit to cause machine malfunction when you apply pressure.

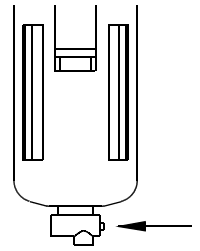

Lock Lever

When it is hard to grip the lock lever, we recommend you to lubricate into the gap between lock sleeve and lock rod to avoid broken of lock lever.

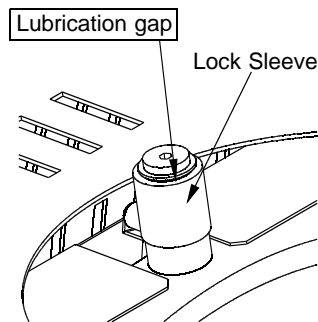

Lock Rod expansion drawing

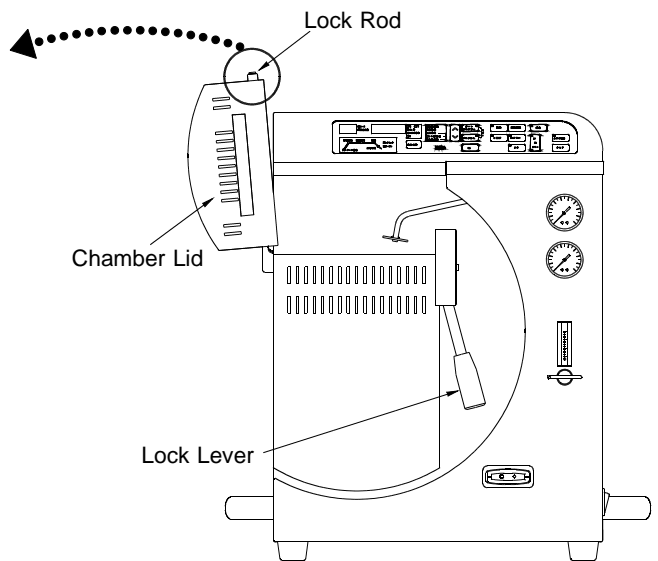

Maintenance of Muffle

In case to clean the stuck metal and the debris on the surface of muffle and to replace the consumables, we recommend you to refer to the following diagram.

Note) Make sure that main power is off and muffle heat is sufficiently low before you start.

Cross Recessed Screw

Used to fix muffle metal ring.

Metal Ring

Donut shaped metal ring to hold down the muffle part.

Metal Shutter

Used to place closely in contact with muffle inside wall to prevent debris from dropping into muffle.

Metal Plate

A specific metal plate to protect muffle when casting ring touches muffle top surface.

Ceramic Ring, small (consumables)

Heat insulating ring in grey to fix retort.

We recommend you to replace the ceramic plate in case of damaged when the retort is replaced.

Retort N.S.C (consumables)

Heat resistant ceramic and used to hold a crucible with melted alloy in it. If ceramic crucible is stuck to retort when you remove it after casting operation, glass-like substances are gathered in the bottom of retort. The continued use of the retort will diminish the crucible life and we recommend you to replace.

Ceramic Plate, large

A specific heat resistant ceramic plate in grey to maintain retort from high heat of muffle.

Fiber Sheet (consumables)

An insulating fiber material that intercepts high heat from muffle and prevents debris from entering the muffle. We recommend you to replace the fiber sheet when the retort N.S.C is replaced.

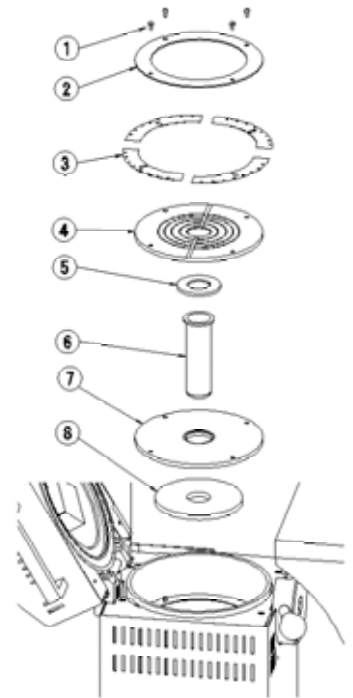

Consumables

The list of consumables.

Name	QTY.
Carbon Washer Kit	10 pcs
Carbon Crucible S.CAS	10 pcs
Ceramic Crucible N.S.C	10 pcs
Casting Rings 1 3/4" diam.(43mm)	3 pcs
Casting Rings 2 3/8" diam.(60mm)	3 pcs
Casting Rings 3" diam.(76mm)	2 pcs
Casting Rings 3 1/2" diam.(90mm)	1 pc
Sprue Formers 1 3/4" diam.(43mm)	3 pcs
Sprue Formers 2 3/8" diam.(60mm)	3 pcs
Sprue Formers 3" diam.(76mm)	2 pcs
Sprue Formers 3 1/2" diam.(90mm)	1 pc
Crucible Former	100 pcs
Retort N.S.C	1 pc
Ceramic Ring	1 pc

Trouble Shootings

When you find your unit is in trouble, we recommend you to check the problem with those guides listed below before you send out for repair. If the guide below does not solve the problem, contact the nearest dealer or manufacturer.

Troubles	Causes	Recommendations for solution
Display does not light up.	Is the unit unplugged ?	Plug in the unit
	Is the power switch off ?	Turn the power switch on
	Power goes off despite of power being switched on.	Contact dealer or manufacturer
Muffle is not heating up or slow in heat up	Is muffle heat below 212 °F (100 °C)?	Power flow to heater in low heat level is restricted to sustain muffle life. This is not abnormal.
	Is start temp. programmed low ?	Check the programmed start temp to revise or to adjust. P12
The machine makes a buzzing sound	Is muffle in heat rise ?	When the small lamp on the bottom right of the 4 digit display is illuminated, it may sound buzzing. This is not abnormal.
The pocket pager does not work	The pager has not received data from the unit properly.	Refer to P17 and follow the instruction for recheck.
The cycle counter will not read ceramic crucible data	Is the bar code on the crucible contaminated or chipped ?	Use of a new ceramic crucible is recommendable.
Er 77 is displayed	Abnormal vacuum level. Vacuum pump is unable to reach a proper level.	Is the vacuum pump fuse blown ? While you press the vacuum pump fuse lightly with a driver, turn the fuse approx. 60 ° counter clockwise to draw out the fuse for replacement. The rating of the fuse in 125V, M10A is recommended.
Er 77 is displayed after finish of casting operation	Vacuum pump may be deteriorated or a proper vacuum level was not obtained by vacuum leak.	This enables you to cast but you may have a miscasting. Contact to manufacturer is recommendable.
no CHEC are displayed.	Crucible cycle was not checked.	Place the crucible in the cycle counter to make sure if the crucible is good for use or not. P13
Affection to receivers such as radios by the noise.	When the unit is in operation, you may have occasions when your radio receiver in the vicinity will be attacked by the noises generated from the unit.	Keep away the receivers such as radios from the unit.

Error Messages

When the error codes shown below are displayed we recommend you to contact the manufacturer. The following errors may sometimes be displayed in cases when there is extreme interference. Please turn off the unit and on again to see if the error code persists.

The followings are considered to be possible sources of interference.

- Lightning strikes
- Induction or arc casting machine in the vicinity
- Radio transmitter in the vicinity
- Induction motor in the vicinity

Er 0 Unit unable to read power outlet frequency

Er 1 Control system is malfunctioning

Er 2 Memory function is abnormal
RAM malfunction for program parameters, default values etc.

Er 3 Malfunction of chamber clockwise rotation

Er 4 Malfunction of chamber counter clockwise rotation

Er 5 Power control to muffle heater is malfunctioning
Possibly muffle heater breakdown is anticipated

Er 6 Thermocouple is malfunctioning
Thermocouple breakdown is anticipated

Er 8 Abnormal memory
Data in memory is out of normal programmable range

Er 9 Abnormal heat rise
The error code is displayed when the muffle heat is abnormally high

Er 10 Device malfunction of current flow to muffle heater
Computer detects current flow signal despite no current is flowing to heater

Er 11 Malfunction of temperature detection device
Temperature signal is not received from thermocouple

Er 12 Abnormal over pressure
Chamber pressure is higher than set level

Er 13 Abnormal low pressure
Chamber pressure is lower than set level

Er 20 Abnormal control P.C.B.
The error code is displayed in case the P.C.B is out of control.

HEAT is displayed

When the unit is re-booted after **Er 5** is displayed, **HEAT** is displayed. The trouble of **Er 5** should be solved for machine operation. We recommend you to contact dealer/manufacturer for trouble shooting.

Main Specifications

Power Requirement	AC 120V \pm 10% 50/60Hz		
Power Consumption	1500VA		
Overall Dimensions	19 27/32" (504mm) (W) \times 20 7/8" (530mm) (H) \times 20 1/2" (521mm) (D)		
Weight, Main Body	49.8kg (109.8 lbs)		
Environment for Setup	Room Temp.	50 ~ 104 °F (10 ~ 40)	
	Humidity	30 ~ 90 % RH noncondensing	
	Altitude	0 ~ 6562feet (0 ~ 2000m)	
Max. Muffle Temp.	2786 °F (1530) (Carbon crucible max. temp.2642 °F (1450))		
Heating Method	Ceramic Heating Element		
Crucible Size	1"diam. \times 3 7/8" (25diam. \times 98.5mm) custom made		
Casting Rings	1 11/16" ~ 3 17/32" (43 ~ 90mm) diam. H =1 9/16" ~ 2 3/4" (40 ~ 70mm)		
Program Memory Capacity	100 programs		
Required Air Pressure	0.5 ~ 1MPa (73 ~ 145psi)		
Required Argon Gas Pressure	0.7 ~ 0.8MPa (102 ~ 116psi)		
Argon Nozzle	Automatic		
Pressure Atmosphere	Air or Argon gas		
Melting Atmosphere	Air or Argon gas		
Ceramic Crucible Cast Cycles	2552 ~ 2786 °F (1400 ~ 1530) : 1 casting		
	Below 2552 °F (1400) = 0.5 cast : Total 10 castings per crucible		
Casting Method	Chamber inverting and vacuum pressure casting system		
Programmable Parameters	Auto Program :		
	Liquidus temp. , Alloy quantity, Investment type and Crucible type		
	Manual Program :		
Parameters and Programmable Scopes	Start temp., Melt temp., Melt time, Cast timing, Cool time and Crucible type		
	Liquidus Temp.	32 ~ 2786 °F (0 ~ 1530) in 1 °F (1) unit	
	Melting Quantity	0 ~ 150g (0 ~ 5.3 Oz.) in 1g (0.035 Oz.) unit	
	Start Temp.	32 ~ 2372 °F (0 ~ 1300) in 1 °F (1) unit	
	Melt Temp.	32 ~ 2786 °F (0 ~ 1530) in 1 °F (1) unit	
	Melt Time	0 ~ 15 min. in 5 sec. unit	
	Cast Timing	-0.5 sec. ~ +0.5 sec. in 0.1 sec. unit	
	Cooling Time	5 sec. ~ 10 min. in 5 sec. unit	
	Max. Alloy Melt Quantity	Below 2192 °F (1200)	150g (5.3 Oz.)
		2194 ~ 2372 °F (1201 ~ 1300)	100g (3.5 Oz.)
2374 ~ 2552 °F (1301 ~ 1400)		60g (2.1 Oz.)	
2554 ~ 2786 °F (1401 ~ 1530)		45g (1.6 Oz.)	

kdf u.s. inc.

2301 W.205th Street, Suite 107, Torrance, CA 90501 U.S.A.
 TEL 310-320-6633 FAX 310-320-6116
 e-mail : sales@kdfus.com

denken CO., LTD.

130 Ishigohri-cho, Ohyake, Yamashinaku, Kyoto 607-8187, Japan
 TEL 81-75-571-1000 FAX 81-75-572-9000
 e-mail : denken@kdf.co.jp